

3D | Simulation:

**RF3**

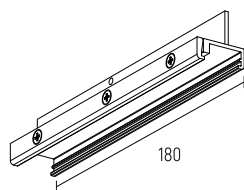

2752050033  W  
2752050034  K

**CLIP3**

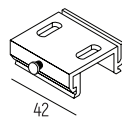

1772050015  W  
1772050017  K

**A3**

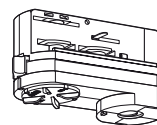

2750160004  W  
2750160005  K

**L3**

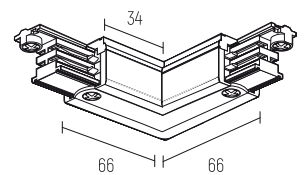

2752050035  W  
2752050036  K

3 CIRCUIT



# C3

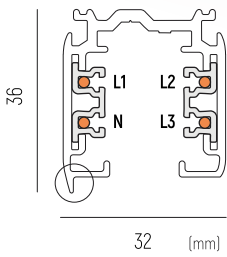
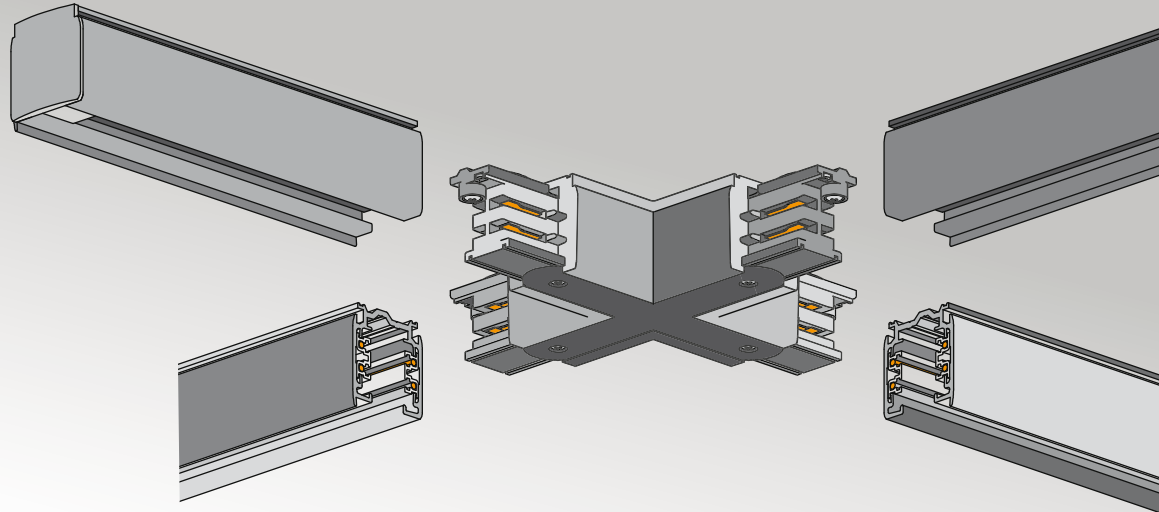

Especificações | Specifications | Spécifications | Especificaciones

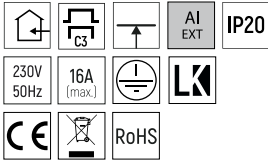

Standards

EN 60570  
EN 60598-1

### C3

W	2750530005	1000mm
	2750530007	2000mm
K	2750530006	1000mm
	2750530008	2000mm

### AL3

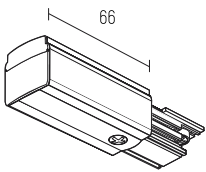

2752050025	W
2752050026	K

### i3

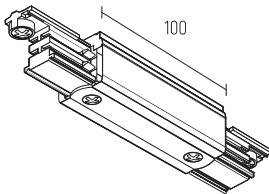

2752050004	W
2752050005	K

### i4

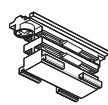

2752050010	W
2752050011	K

### i3FL

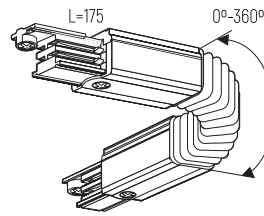

1772050011	W
2752050008	K

### T3

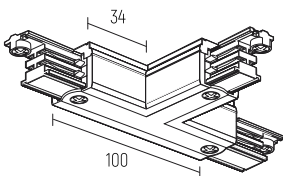

1772050012	W
2752050037	K

### TP3

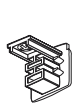

2752050020	W
2752050021	K

### X3

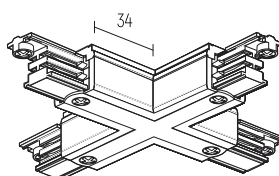

1772050013	W
2752050040	K

### C3FL

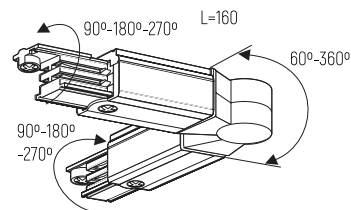

2752050030	W
2752050031	K

### SP3

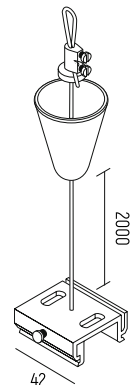

2752050038	W
2752050039	K

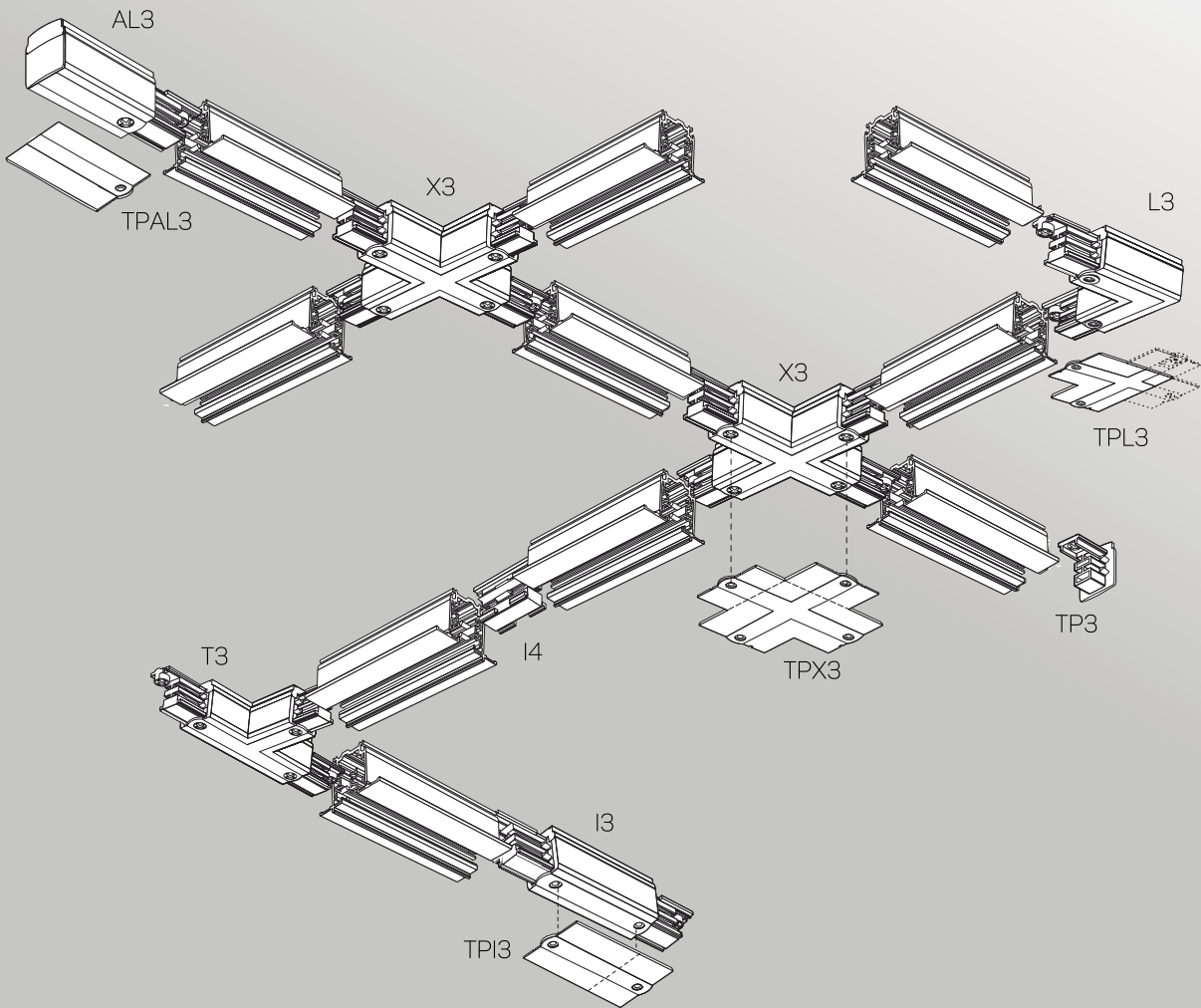

3D | Simulation:

**TPAL3-RCS**

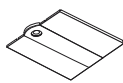

1772050001  W  
1772050016  K

**TPI3-RCS**

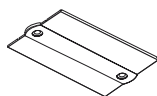

1772050002  W  
1772050018  K

**TPL3-RCS**

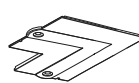

1772050003  W  
1772050019  K

**TPT3-RCS**

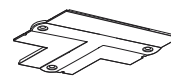

1772050004  W  
1772050020  K

**TPX3-RCS**

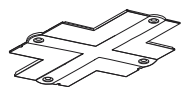

1772050005  W  
1772050021  K

3 CIRCUIT



# C3-RCS

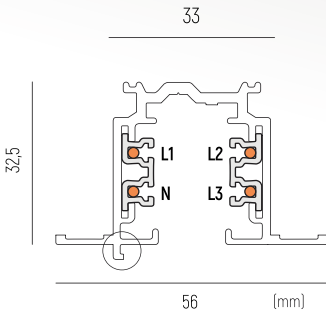

Especificações | Specifications | Spécifications | Especificaciones

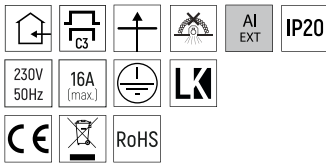

Standards  
EN 60570  
EN 60598-1

## C3-RCS

W	2780530001	1000mm
	2780530003	2000mm
K	2780530002	1000mm
	2780530004	2000mm

### AL3

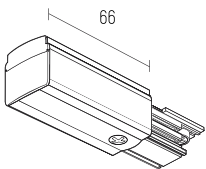

2752050025	W
2752050026	K

### i3

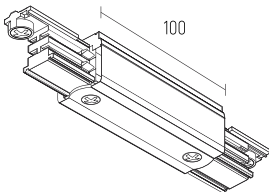

2752050004	W
2752050005	K

### i4

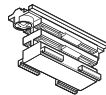

2752050010	W
2752050011	K

### A3



2750160004	W
2750160005	K

### T3

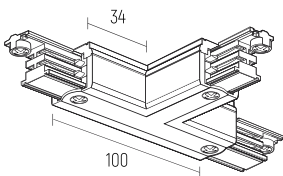

1772050012	W
2752050037	K

### TP3



2752050020	W
2752050021	K

### X3

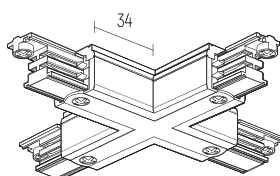

1772050013	W
2752050040	K

### L3

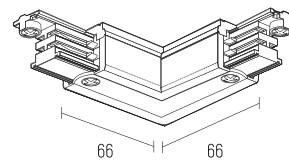

1772050010	W
2752050036	K



1 CIRCUIT



C1

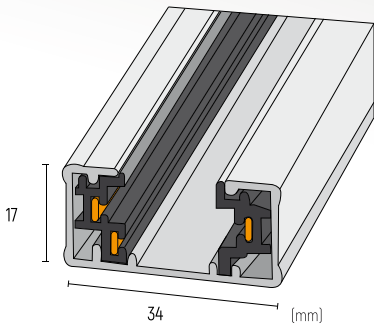

Especificações | Specifications | Spécifications | Especificaciones

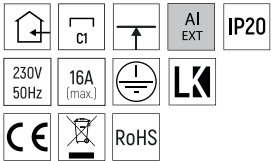

Standards

EN 60570  
EN 60598-1

**C1**

W	2750530015	1000mm
	2750530012	2000mm
K	2750530016	1000mm
	2750530013	2000mm

**AL1**

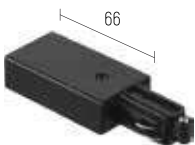

1382050070	W
1382050071	K

**i1**



2752050013	W
2752050014	K

**A1**



2750160001	W
2750160002	K

**T1**

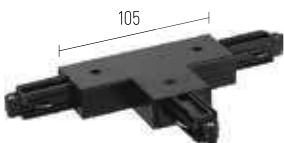

1382050021	W
1382050023	K

**TP1**



1382050060	W
1382050061	K

**X1**

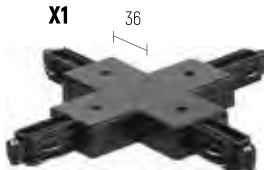

1382050024	W
1382050026	K

**L1**



1382050018	W
1382050020	K